

**RoHS Compliant & Pb-Free Product**

- Typical Applications
- Broadband, Low Noise Gain Blocks
  - IF or RF Buffer Amplifiers
  - Driver Stage for Power Amplifiers
  - Final PA for Low Power Applications
  - Broadband Test Equipment

Product Description

The RF2333 is a general purpose, low-cost RF amplifier IC. The device is manufactured on an advanced Gallium Arsenide Heterojunction Bipolar Transistor (HBT) process, and has been designed for use as an easily-cascadable 50Ω gain block. Applications include IF and RF amplification in wireless voice and data communication products operating in frequency bands up to 6000MHz. The device is self-contained with 50Ω input and output impedances and requires only two external DC biasing elements to operate as specified. The RF2333 is available in a very small industry-standard SOT23-5 surface mount package, enabling compact designs which conserve board space.

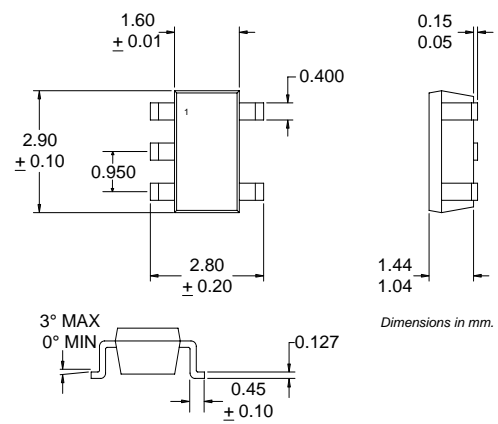

Optimum Technology Matching® Applied

- |                                     |  |                                       |
|-------------------------------------|--|---------------------------------------|
| <input type="checkbox"/> Si BJT     | <input checked="" type="checkbox"/> GaAs HBT | <input type="checkbox"/> GaAs MESFET  |
| <input type="checkbox"/> Si Bi-CMOS | <input type="checkbox"/> SiGe HBT            | <input type="checkbox"/> Si CMOS      |
| <input type="checkbox"/> InGaP/HBT  | <input type="checkbox"/> GaN HEMT            | <input type="checkbox"/> SiGe Bi-CMOS |

Package Style: SOT23-5

- Features
- DC to 6000MHz Operation
  - Internally matched Input and Output
  - 10dB Small Signal Gain
  - +34dBm Output IP3
  - +18.5dBm Output Power
  - Good Gain Flatness

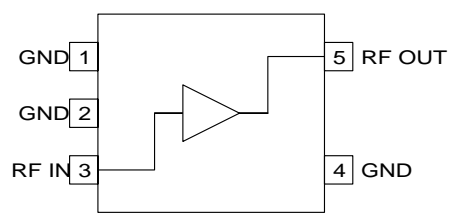

Functional Block Diagram

Ordering Information

RF2333	General Purpose Amplifier
RF2333 PCBA	Fully Assembled Evaluation Board

RF Micro Devices, Inc.  
7628 Thorndike Road  
Greensboro, NC 27409, USA

Tel (336) 664 1233  
Fax (336) 664 0454  
<http://www.rfmd.com>

# RF2333

## Absolute Maximum Ratings

Parameter	Rating	Unit
Input RF Power	+13	dBm
Operating Ambient Temperature	-40 to +85	°C
Storage Temperature	-60 to +150	°C



Caution! ESD sensitive device.

RF Micro Devices believes the furnished information is correct and accurate at the time of this printing. RoHS marking based on EU Directive 2002/95/EC (at time of this printing). However, RF Micro Devices reserves the right to make changes to its products without notice. RF Micro Devices does not assume responsibility for the use of the described product(s).

Parameter	Specification			Unit	Condition
	Min.	Typ.	Max.		
<b>Overall</b>					T=25°C, V <sub>D</sub> =5.5V, I <sub>CC</sub> =70mA
Frequency Range		DC to 6000		MHz	
3dB Bandwidth		6		GHz	
Gain		11.2		dB	Freq=100MHz
		11		dB	Freq=1000MHz
		10.4		dB	Freq=2000MHz
		10.2		dB	Freq=3000MHz
		10			Freq=4000MHz
		9.2			Freq=5000MHz
Gain Flatness		8.3		dB	Freq=6000MHz
Gain Flatness		±0.4		dB	100MHz to 2000MHz
Noise Figure		8.2		dB	Freq=2000MHz
Input VSWR		1.7:1			In a 50Ω system, DC to 4000MHz
Output VSWR		1.7:1			In a 50Ω system, DC to 4000MHz
Output IP <sub>3</sub>		+34.5		dBm	Freq=1000MHz±50kHz, P <sub>TONE</sub> =-10dBm
Output P <sub>1dB</sub>		+18.5		dBm	Freq=1000MHz
Reverse Isolation		17		dB	Freq=2000MHz
<b>Thermal</b>					I <sub>CC</sub> =70mA, P <sub>DISS</sub> =368mW (See Note.)
Theta <sub>JC</sub>		247		°C/W	
Maximum Measured Junction Temperature		176		°C	T <sub>AMB</sub> =+85°C, V <sub>PIN</sub> =5.26V
Mean Time Between Failures		350		years	See Note.
<b>Power Supply</b>					With 22Ω bias resistor
Device Operating Voltage		5.3		V	At pin 5 with I <sub>CC</sub> =70mA
Supply Voltage		6.9		V	At evaluation board connector, I <sub>CC</sub> =70mA
Operating Current			70	mA	See note.

Note: Because of process variations from part to part, the current resulting from a fixed bias voltage will vary. As a result, caution should be used in designing fixed voltage bias circuits to ensure the worst case bias current does not exceed 70mA over all intended operating conditions.

Pin	Function	Description	Interface Schematic
1	GND	Ground connection. For best performance, keep traces physically short and connect immediately to ground plane.	
2	GND	Same as pin 1.	
3	RF IN	RF input pin. This pin is NOT internally DC-blocked. A DC-blocking capacitor, suitable for the frequency of operation, should be used in most applications. DC coupling of the input is not allowed, because this will override the internal feedback loop and cause temperature instability.	
4	GND	Same as pin 1.	
5	RF OUT	RF output and bias pin. Biasing is accomplished with an external series resistor and choke inductor to $V_{CC}$ . The resistor is selected to set the DC current into this pin to a desired level. The resistor value is determined by the following equation: $R = \frac{(V_{SUPPLY} - V_{DEVICE})}{I_{CC}}$ Care should also be taken in the resistor selection to <b>ensure that the current into the part never exceeds 70mA over the planned operating temperature</b> . This means that a resistor between the supply and this pin is always required, even if a supply near 5.5V is available, to provide DC feedback to prevent thermal runaway. Because DC is present on this pin, a DC-blocking capacitor, suitable for the frequency of operation, should be used in most applications. The supply side of the bias network should also be well bypassed.	

## Evaluation Board Schematic

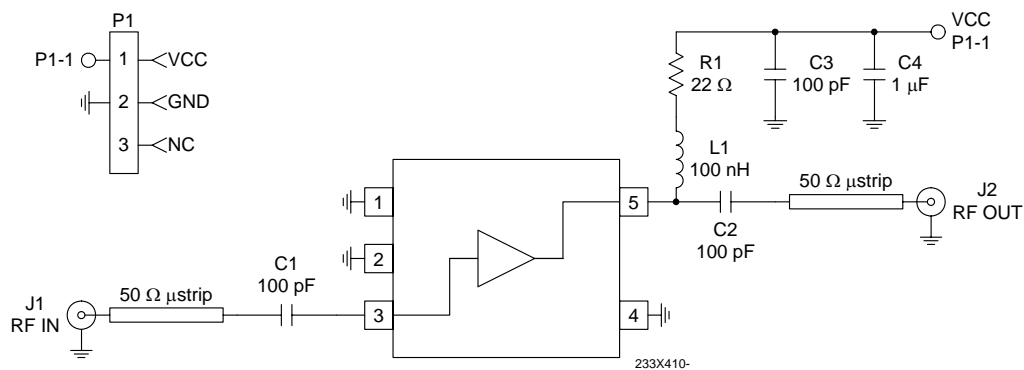

# RF2333

## Evaluation Board Layout Board Size 1.0" x 1.0"

Board Thickness 0.020", Board Material R0-4003 Rogers

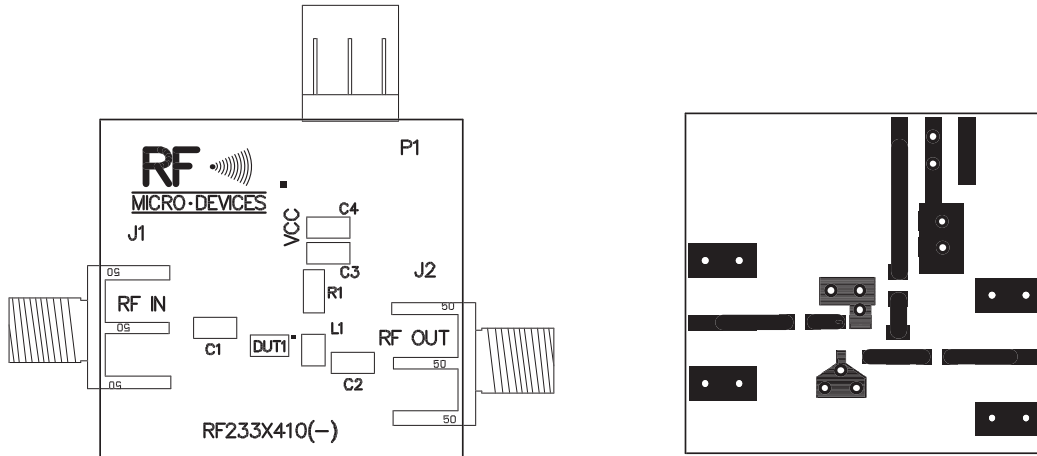

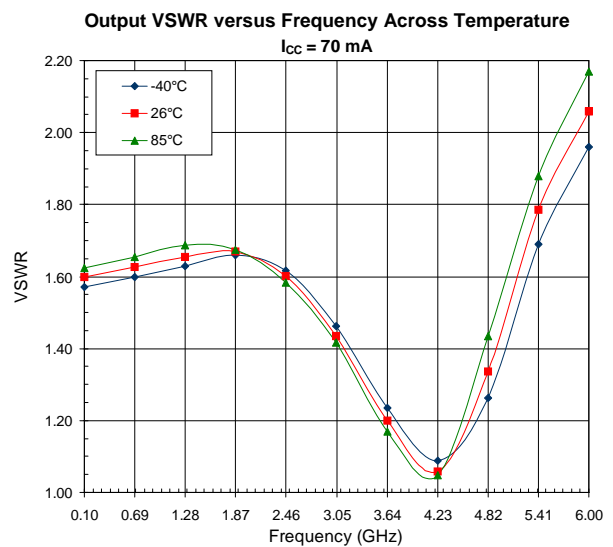
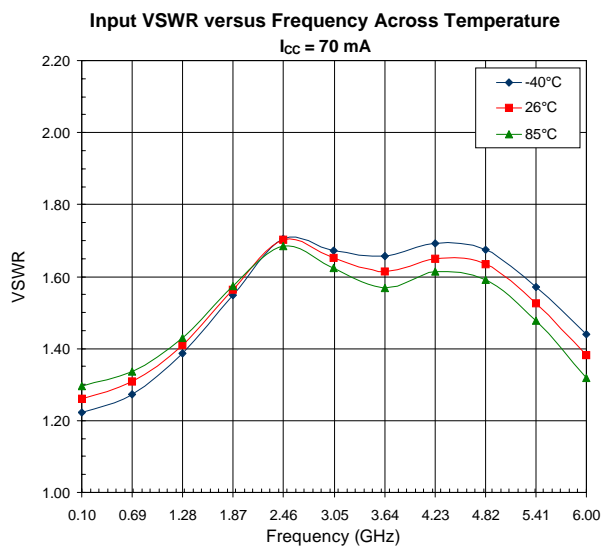
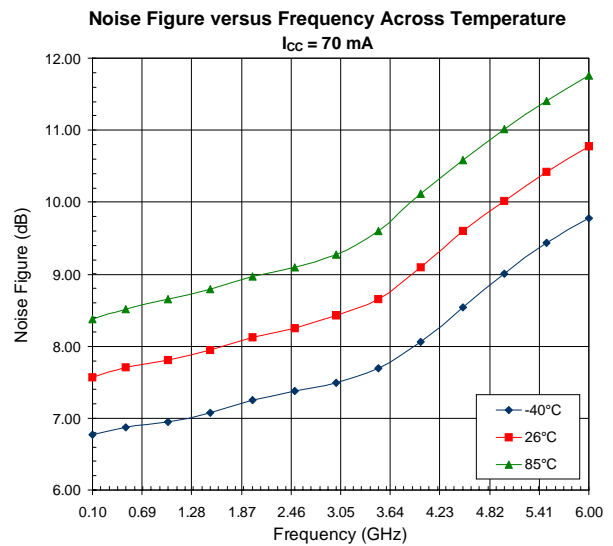
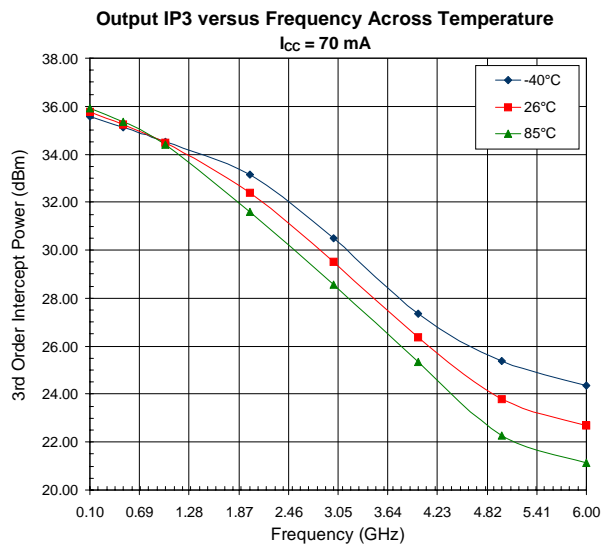
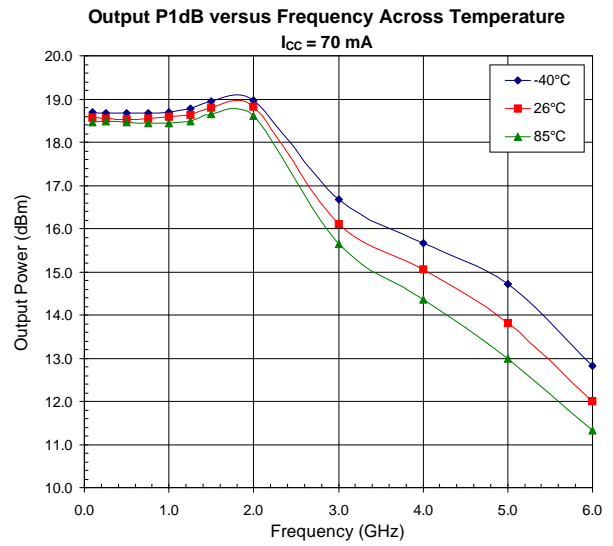
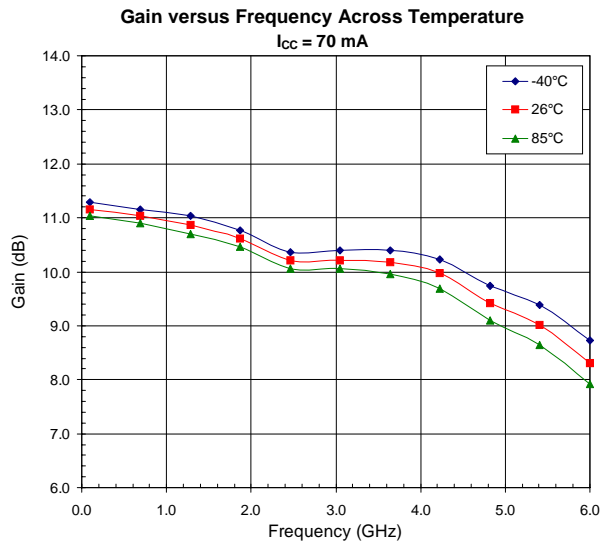

# RF2333

**Reverse Isolation versus Frequency Across Temperature,  $I_{CC} = 70 \text{ mA}$**

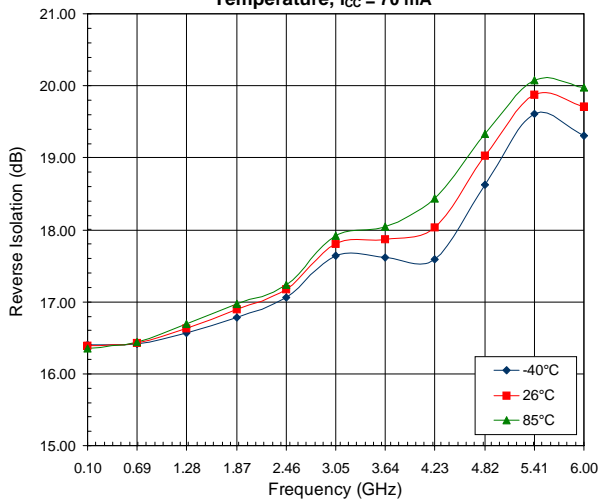

**Current versus Voltage at Evaluation Board Connector,  $R_{BIAS} = 22 \Omega$**

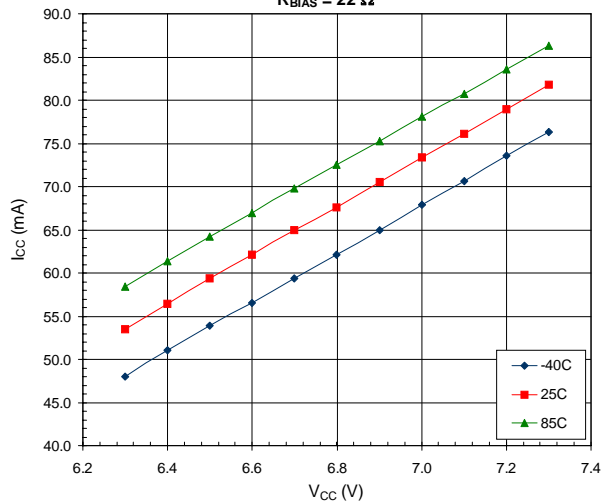

**Current versus Voltage (At Pin 5)**

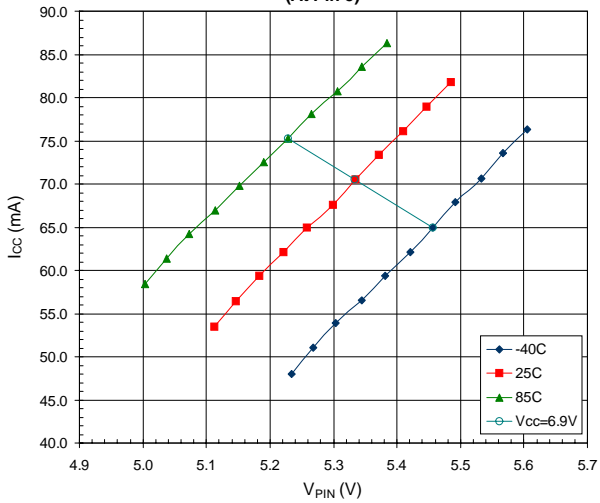

**Power Dissipated versus Voltage at Pin 5 ( $T_{AMBIENT} = +85^\circ\text{C}$ )**

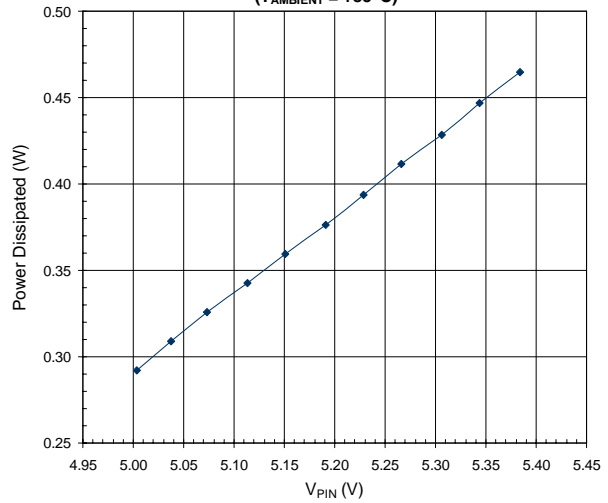

**Junction Temperature versus Power Dissipated ( $T_{AMBIENT} = +85^\circ\text{C}$ )**

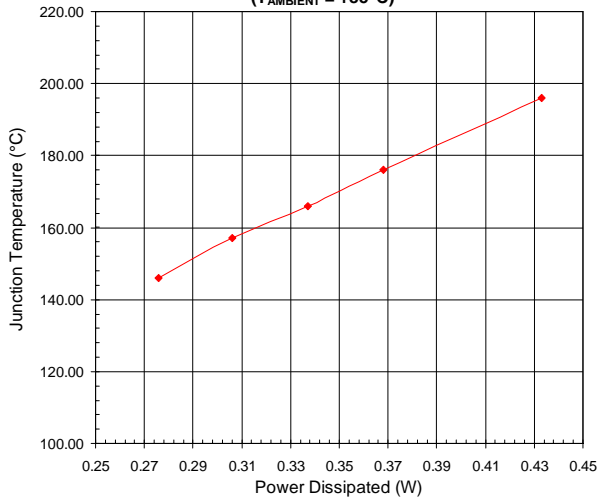

**MTTF versus Junction Temperature (60% Confidence Interval)**

